

DRAWING NO.  
SD030947-01

REV	DATE	DESCRIPTION	ECO	BY	C'H'K.
A	11/11/2011 00:00:00 AM	REDRAWN TO PROE	26042	RG	MA

WIRE MIL-W-5086 AND STD. COM'L	STUD SIZE	CATALOG NO.	FIG. NO.	B MIN.	C		J MAX. COND. INS. DIA.	Y MAX.	K		N MIN.	T		D MAX.	Z MIN.	NYLON SLEEVE COLOR
					DIM.	TOL.			DIM.	TOL.		DIM.	TOL.			
D AN20-AN26	2	YAE22Z1	1	.125	.183	±.015	.105	.626	.101	±.005	.112	.025	±.003	.007	.205	AMBER
	4, 5, 6	YAE22Z2	1		.281			.666	.147					.146	.236	
	6, 7, 8	YAE22Z3	1		.312			.697	.173					.202	.275	
	8, 9, 10	YAE22Z4	1		.359			.746	.198					.232	.322	
	4, 5, 6	YAE22N52F	2		.281			.666	.147					.094	.236	
	4	YAE22Z7	5		.188			.579	.119					.138	.1010	
AN22-AN16	2	YAE18Z1	1	.156	.178	±.20	.125	.701	.101	±.005	.112	.032	±.003	.007	.205	RED
	4	YAE18N60F	2		.211			.731	.116					.189	.238	
	4, 5, 6	YAE18G43F	2		.250			.677	.147					.093	.183	
	4, 5, 6	YAE18N56F	2		.281			.706	.147					.114	.205	
	4, 5, 6	YAE18Z2	3		.281			.741	.147					.140	.236	
	6, 7	YAE18N61F	2		.274			.757	.165					.163	.261	
	6, 7, 8	YAE18Z3	1		.312			.771	.173					.202	.275	
	6, 7, 8	YAE18N57F	2		.312			.771	.173					.175	.277	
	8, 9, 10	YAE18N58F	2		.359			.822	.198					.188	.325	
	8, 9, 10	YAE18Z4	1		.359			.822	.198					.237	.322	
	5M/M	YAE18Z5	1		.359			.825	.207					.234	.331	
	2	YAE18N55F	2		.178			.707	.101					.088	.213	
	C AN20-AN26	2	YAE22N65F		4			.109	.183					±.015	.105	
4, 5, 6		YAE22N66F	4	.281	.671	.147	.122		.265							
6, 7, 8		YAE22N67F	2	.312	.705	.173	.184		.304							
8, 9, 10		YAE22N68F	2	.359	.754	.198	.221		.365							
4, 5, 6		YAE22N70F	4	.250	.671	.147	.122		.265							

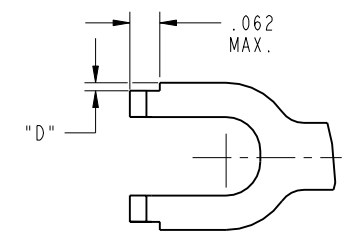

ALTERNATE METHOD FOR FIGS 1, 3, 5 ONLY.

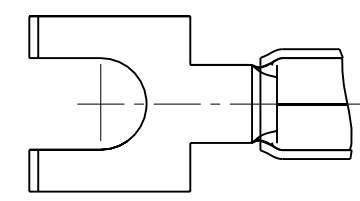
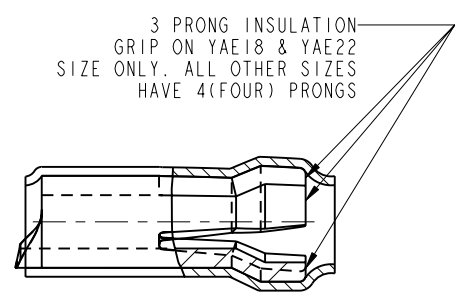

FIG. 5



SECTION A-A

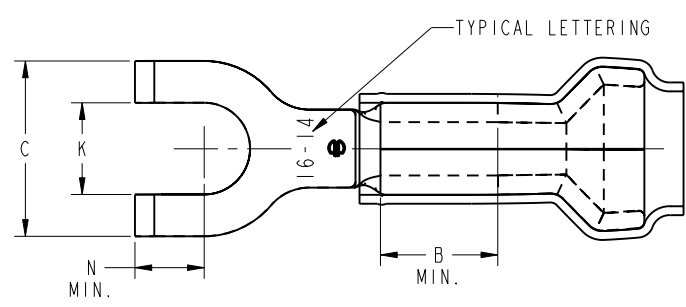

FIG. 1

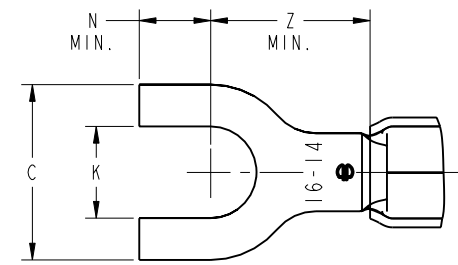

FIG. 2

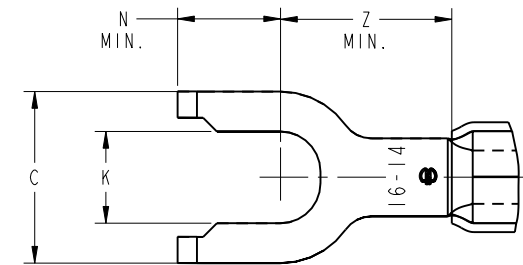

FIG. 3

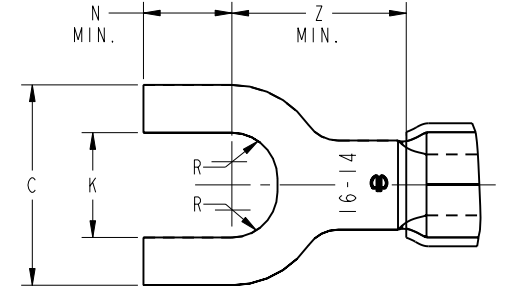
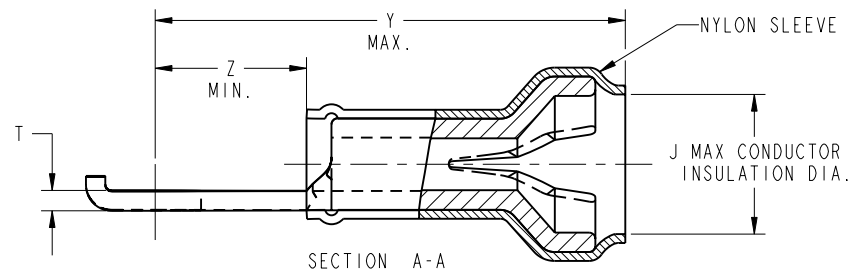
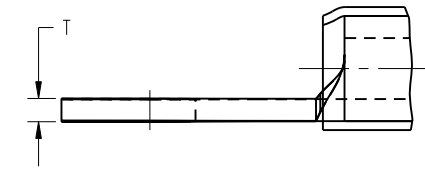
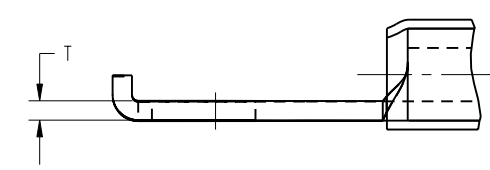
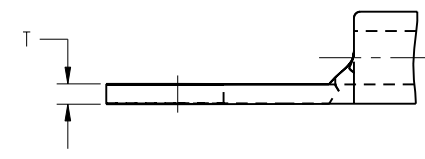

FIG. 4



SECTION A-A



- NOTES:
- MATERIAL:  
INSULATION: NYLON  
TERMINAL: COPPER
  - FINISH:  
TERMINAL: ELECTRO TIN PLATE-STANDARD

TO ORDER BURNDY <sup>®</sup> PRC	INSULUG			
	ITEM NO:	643735		
	CAT. NO:	YAE-Z, N, G (SEE TABLE)		
	DRAWN BY:	C. RAJEEV	11/10/11	
	CHECKER:	E. MARTIN	11/10/11	
	DSN APPVL:	E. MARTIN	11/10/11	
	MFG APPVL:	L. LEAVITT	11/16/11	
	QA APPVL:	C. ACKERMAN	11/10/11	
	MKT APPVL:	J. SYLVIA	11/10/11	
	PROD FAM:	CM&R	DRAWING NO	REV
PROJECT #:	--	SD030947-01	A	
DOCUMENT TYPE:	Production	SIZE	D	
REL LEVEL:	Released	SHEET	1 OF 1	

REV: PE0200